

# 24V LED Tape DMX Driver

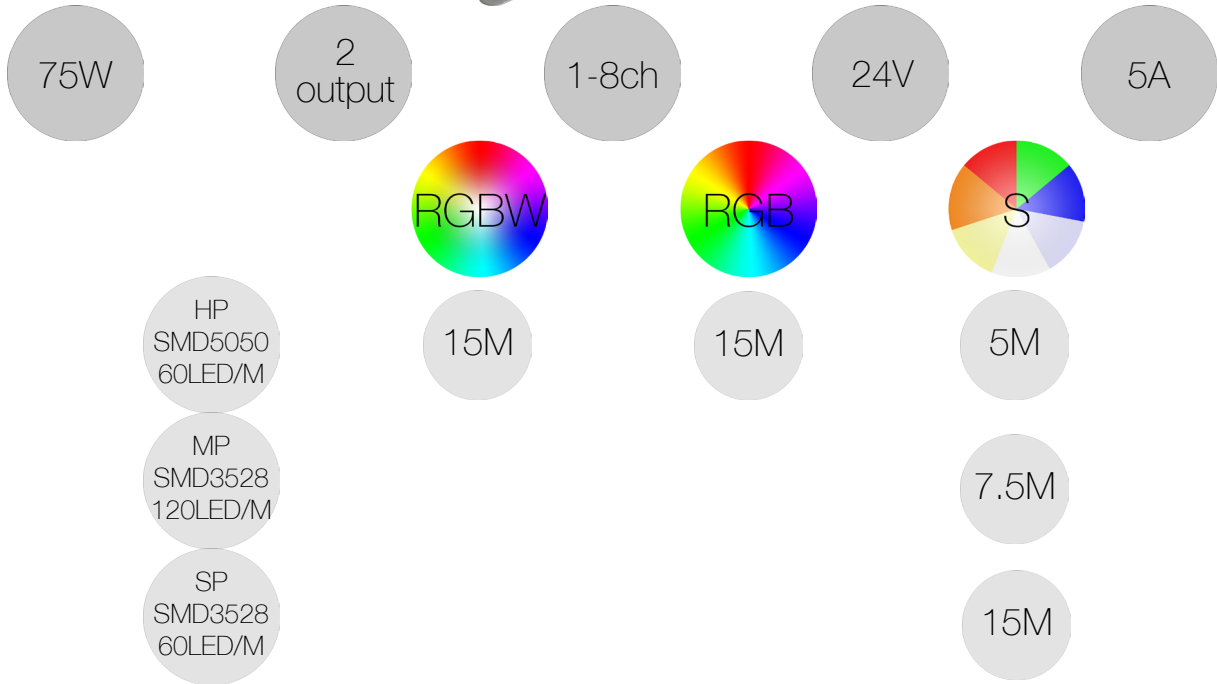

110-240VAC  
Input Voltage

24V  
Output Voltage

5A  
Max Output Current

75W  
Max Power Consumption

Power Balance Software

1-8 Channel  
2 x Output

IP20  
Ingress Protection

Phoenix  
Output Connectivity

-10°C / +40°C  
Operating Temp

Cooling System:  
Convection



Tel: +44 (0) 116 278 8078  
Email: [sales@abstractavr.com](mailto:sales@abstractavr.com)  
Website: [www.abstractavr.com](http://www.abstractavr.com)



User Data - Specifications  
Date: 01/11/2016  
Page 1/5

# 24V LED Tape DMX Driver

Dimensions

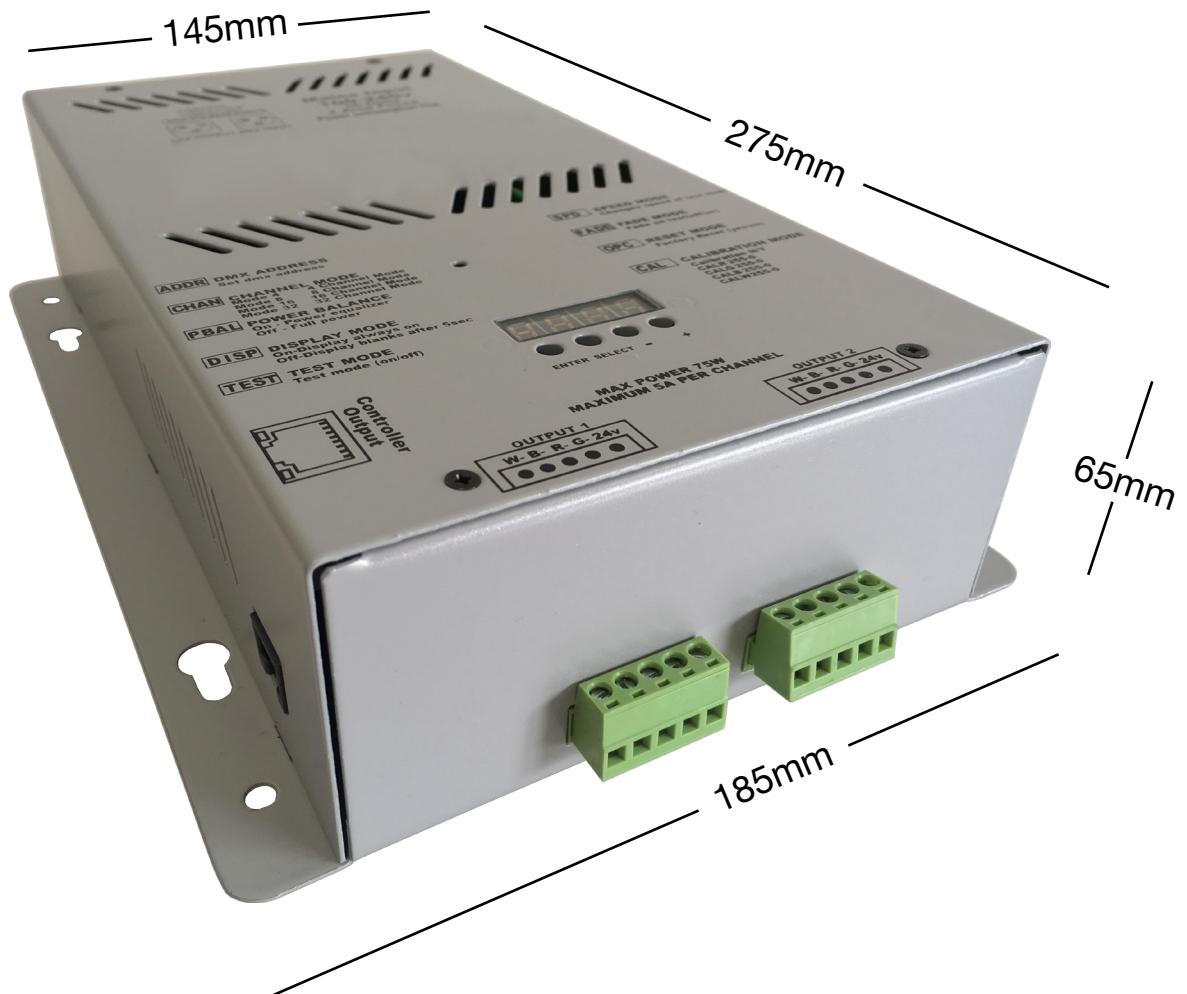

# 24V LED Tape DMX Driver

## Wiring Connections

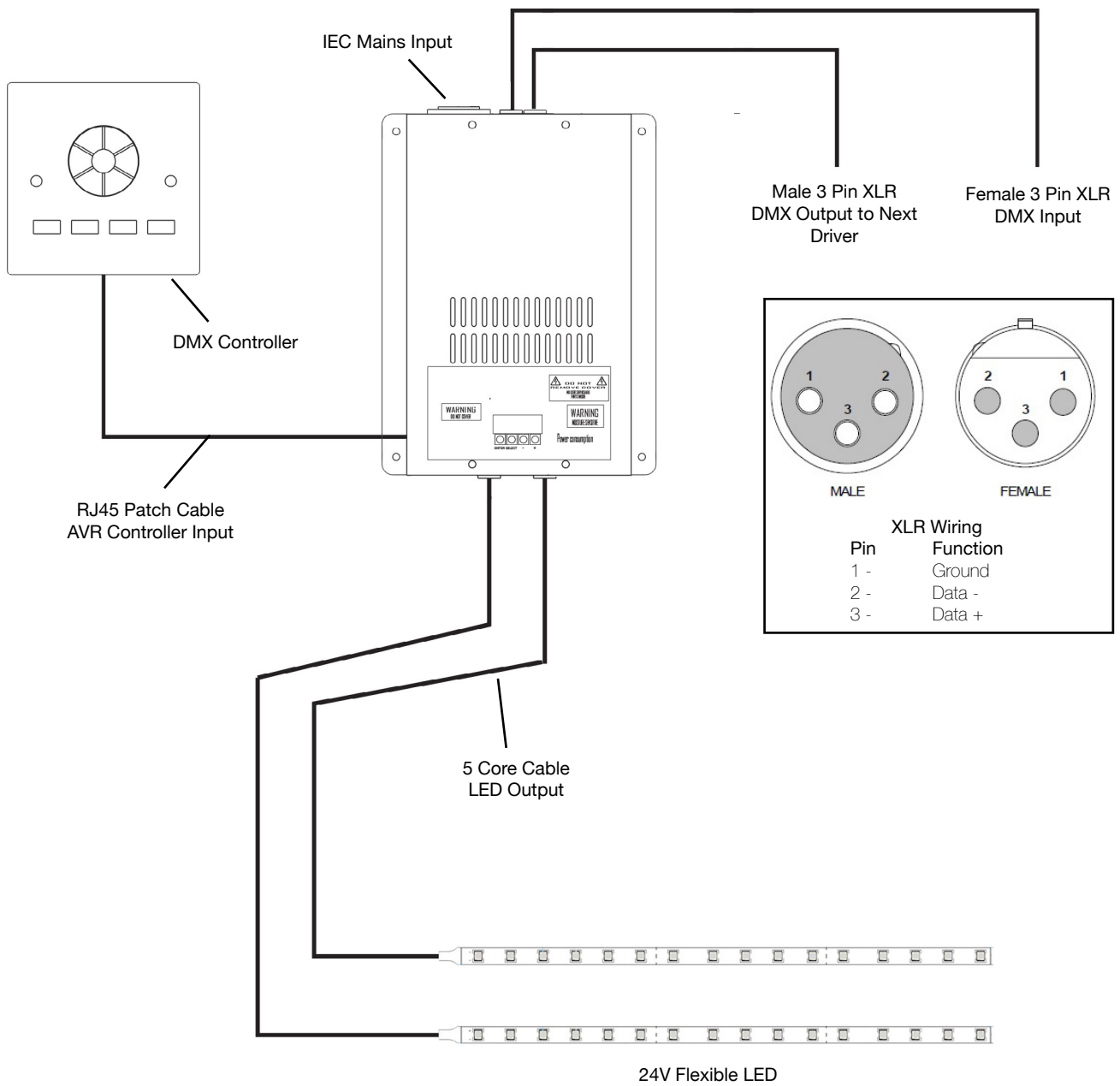
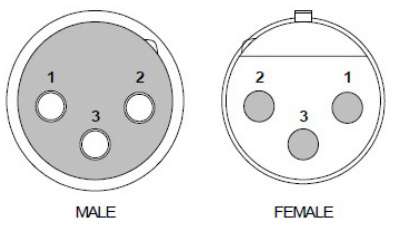

RJ45 Wiring		
Pin	Colour	Function
1 -	Orange/White	Data +
2 -	Orange	Data -
4 -	Blue	24V
8 -	Brown	Ground

XLR Wiring	
Pin	Function
1 -	Ground
2 -	Data -
3 -	Data +



# Colour Change Flexible LED System Wiring

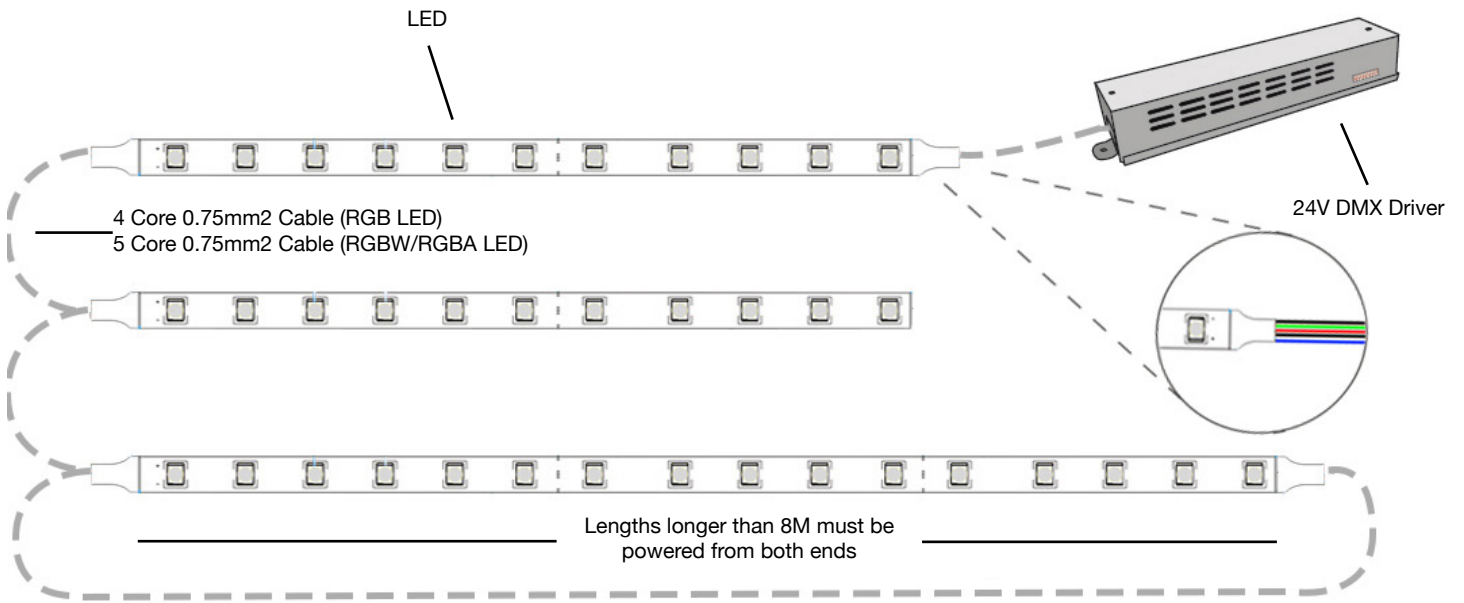

**WARNING!** Example diagram only. Please read this section carefully before any installation work is carried out. All work should be carried out as per our instructions. Failure to do so may void any warranty. These instructions are to be used in addition to the Driver manuals.

## IMPORTANT

All work involving electrical components should be carried out by a competent qualified electrical professional in accordance to IET BS 7671 and any local by-laws.

Installation instructions are for the installation of this product with the manufacturer's compatible recommended DMX drivers.

All mains power **MUST** be turned off before starting installation or maintenance; and **MUST** remain off for the duration of installation or maintenance.

Equipment may become hot to the touch when used for periods of time. Ensure equipment is off and cooled before carrying out maintenance.

The total combined length of colour change flexible LED connected to any single 'LED' output **MUST NOT EXCEED 15M**.

Any continuous lengths of LED exceeding 8M **MUST** be powered from both ends, as per wiring diagram.

## TESTING

You should test each length of LED in isolation before continuing installation.

1. Disconnect the Driver from mains power.
2. Connect length of LED to the 'LED' socket of the Driver in isolation.
3. Power up the Driver.
4. Press 'ENT' continuously to select RED, GREEN, BLUE and WHITE.
5. Repeat steps 1 to 4, for each length of LED.

If each length lights up and displays each colour you can continue with your installation.

If a length does not light up or display each colour please contact us for help. Do not continue your installation.

## INSTALLATION

Ensure you have carried out the testing before installation.

1. Cut or solder LED to desired length using the designated cutting and soldering points.
2. Disconnect the Driver from mains power.
3. Connect LED to LED socket, ensuring that the colours are connected to the correct poles.
4. Additional lengths can be connected to the same LED output in parallel, ensuring you do not exceed a total length of 15M on any single LED output.
5. Repeat steps 1 - 4 for each length of LED.

Wiring		
Pin	Function	Wire
1 -	White - / Amber -	White
2 -	Blue -	Blue
3 -	Red -	Red
4 -	Green -	Green
5 -	24V	Black



# Single Colour Flexible LED User Data

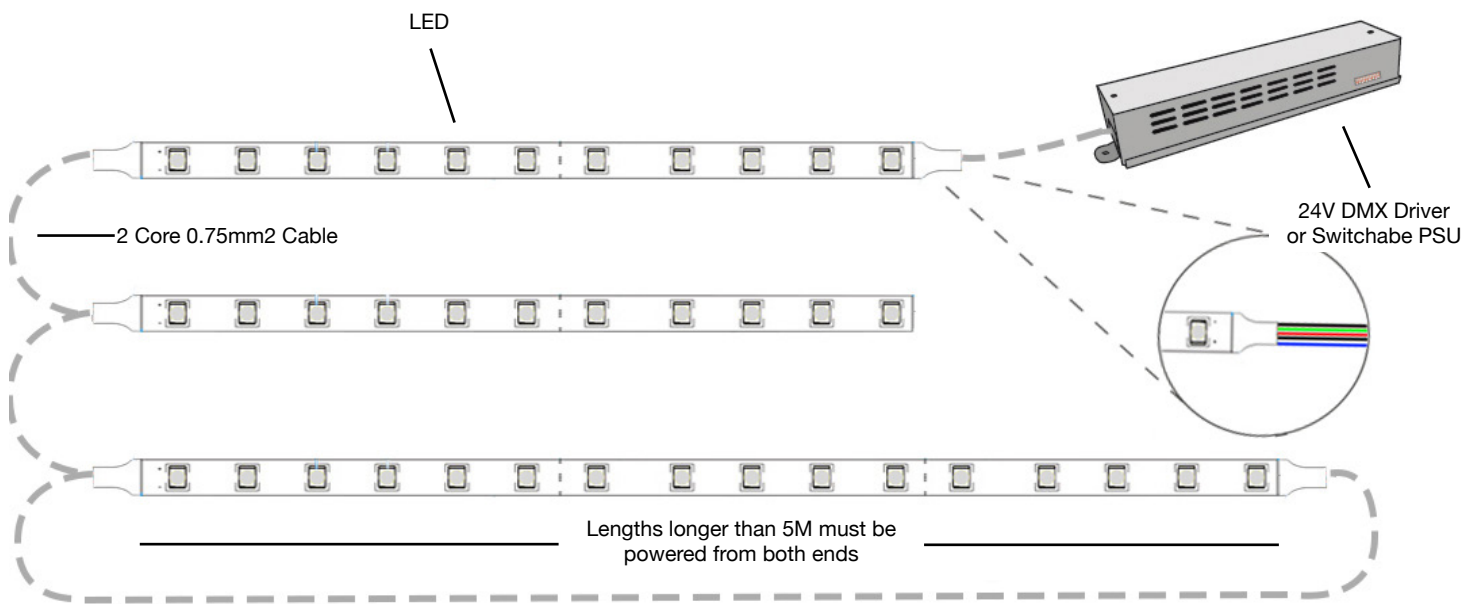

**WARNING!** Example diagram only. Please read this section carefully before any installation work is carried out. All work should be carried out as per our instructions. Failure to do so may void any warranty. These instructions are to be used in addition to the Driver manuals.

## IMPORTANT

All work involving electrical components should be carried out by a competent qualified electrical professional in accordance to IET BS 7671 and any local by-laws.

Installation instructions are for the installation of this product with the manufacturer's compatible recommended DMX drivers.

All mains power **MUST** be turned off before starting installation or maintenance; and **MUST** remain off for the duration of installation or maintenance.

Equipment may become hot to the touch when used for periods of time. Ensure equipment is off and cooled before carrying out maintenance.

The total combined wattage of any colour change flexible LED connected to any single 'LED' output of DMX driver **MUST NOT EXCEED 75W** or **MUST NOT EXCEED** the PSU's power rating.

Any continuous lengths of LED exceeding 5M **MUST** be powered from both ends, as per wiring diagram.

## TESTING

You should test each length of LED in isolation before continuing installation.

1. Disconnect the Driver from mains power.
2. Connect length of LED to the 'LED' socket of the Driver or switchable PSU in isolation.
3. Power up the Driver.
4. DMX Drive: Press 'ENT' until you select channel that the length of LED is wired into.
5. Repeat steps 1 to 4, for each length of LED.

If each length lights up you can continue with your installation.

If a length does not light up please contact us for help. Do not continue your installation.

## INSTALLATION

Ensure you have carried out the testing before installation.

1. Cut or solder LED to desired length using the designated cutting and soldering points.
2. Disconnect the Driver from mains power.
3. Connect LED to LED socket, ensuring that the colours are connected to the correct poles.
4. Additional lengths can be connected to the same LED output in parallel, ensuring you do not exceed the PSU's rated power.
5. Repeat steps 1 - 4 for each length of LED.

Wiring		
Pin	Function	Wire
1/2/3/4	GND -	Black
5	24V	Red

